

THREADED SPACER

PLASTECH

1

- MATERIAL: NYLON 66 (UL)
- FLAME CLASS :94V-2
- COLOR:NATURAL
- UNIT:mm

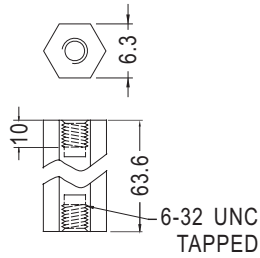
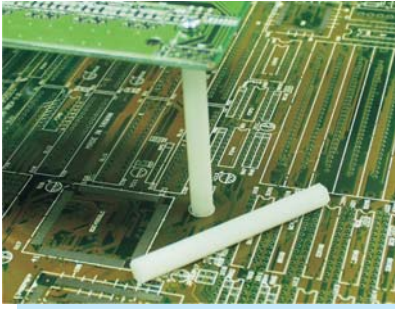

PART NO	PACKAGE
HP632-64	250

- MATERIAL:POM (UL) 94HB

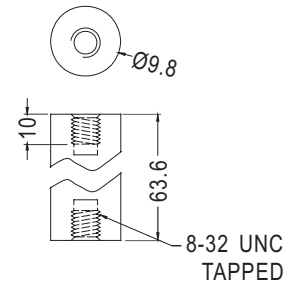

PART NO	PACKAGE
HPP10-64	250

THREADED SPACER

PLASTECH

- MATERIAL:POM (UL)
- FLAME CLASS :94HB
- COLOR:NATURAL
- UNIT:mm

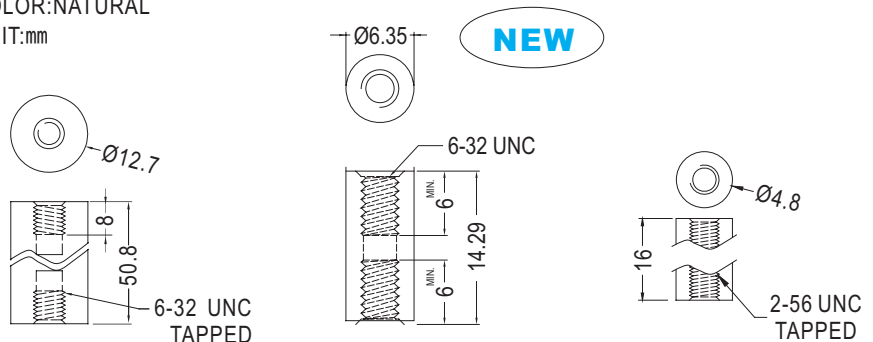

PART NO	PACKAGE
HPP632-51	250

PART NO	PACKAGE
HPP632-14	1000

PART NO	PACKAGE
HP256-16	1000

THREADED SPACER

PLASTECH

- MATERIAL:NYLON 66 (UL)
- FLAME CLASS:94V-0/94V-2
- INSERT MATERIAL:BRASS
- COLOR:BLACK
- UNIT:mm

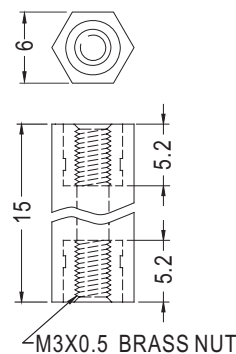
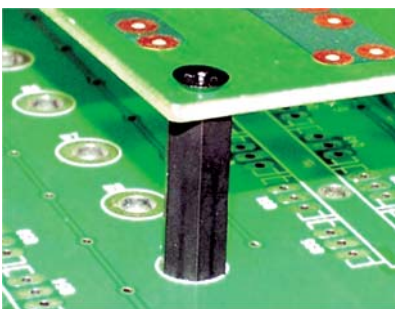

PART NO	PACKAGE
HPC-15	1000

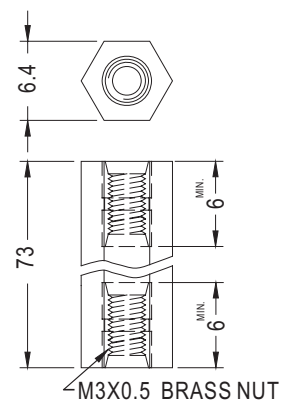

PART NO	PACKAGE
HPC-73	1000