

LED SPACER SUPPORT

PLASTECH

- MATERIAL: NYLON 66 (UL)
- FLAME CLASS :94V-2
- COLOR: BLACK
- UNIT: mm

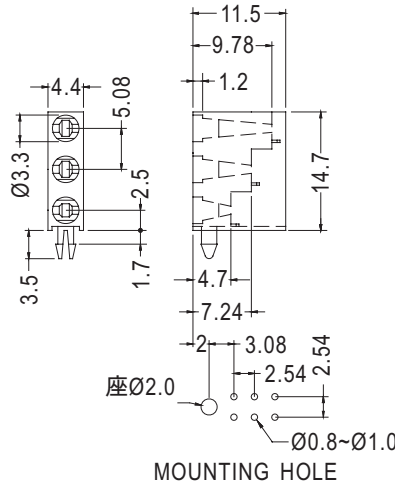
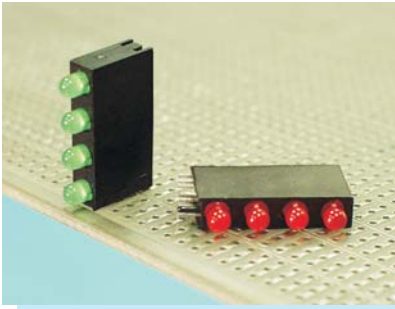
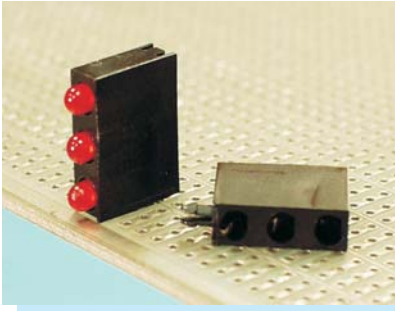

PART NO	PACKAGE
LEK-330	1000

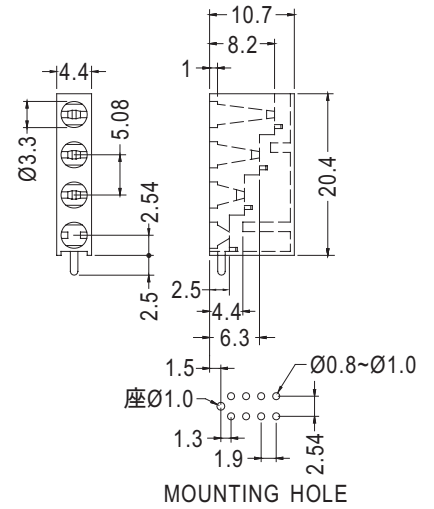

PART NO	PACKAGE
LEK-340	1000

LED SPACER SUPPORT

PLASTECH

- MATERIAL: NYLON 66 (UL)
- FLAME CLASS :94V-2
- COLOR: BLACK
- UNIT: mm

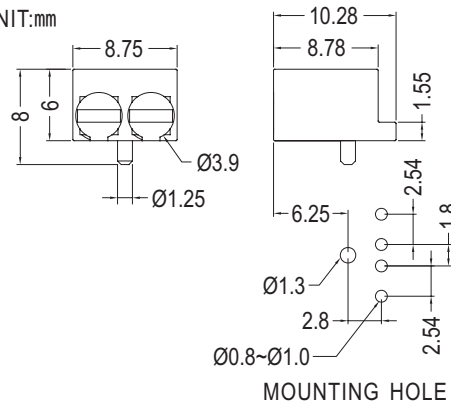
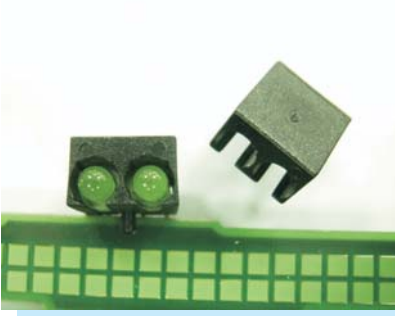

NEW

PART NO	PACKAGE
LEK-316	2000

LED SPACER SUPPORT

PLASTECH

- MATERIAL: NYLON 66 (UL)
- FLAME CLASS :94V-2
- COLOR: BLACK
- UNIT: mm

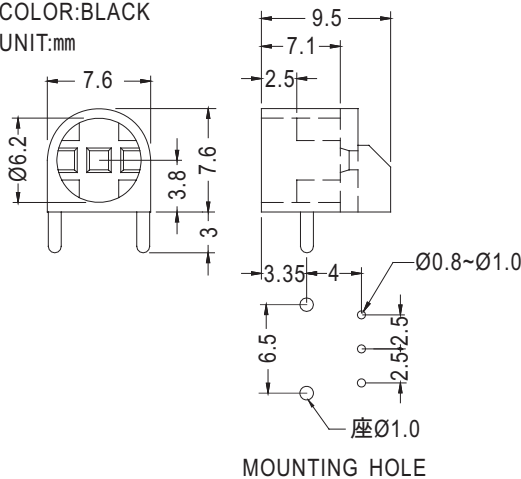
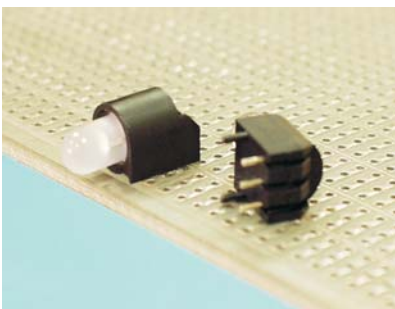

PART NO	PACKAGE
LEK-501	1000