

LED SPACER SUPPORT

PLASTECH

- MATERIAL: NYLON 66 (UL)
- FLAME CLASS :94V-2
- COLOR: BLACK
- UNIT: mm

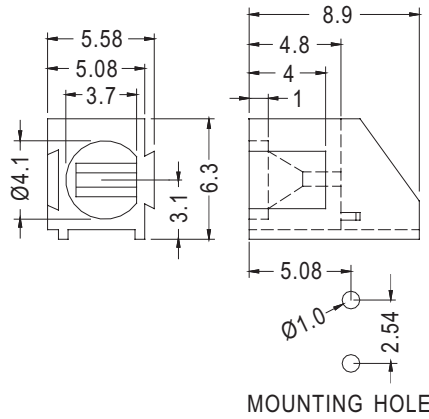

PART NO	PACKAGE
LED-6301	2000

3

LED SPACER SUPPORT

PLASTECH

- MATERIAL: NYLON 66 (UL)
- FLAME CLASS :94V-2
- COLOR: BLACK
- UNIT: mm

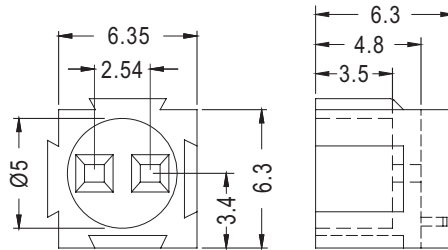
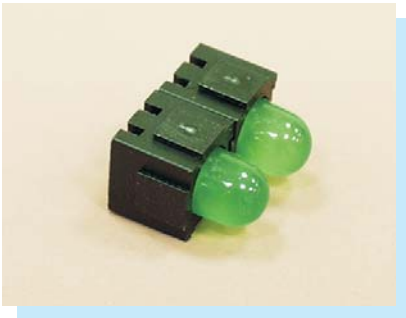

PART NO	PACKAGE
LED-6501	2000

LED SPACER SUPPORT

PLASTECH

- MATERIAL: NYLON 66 (UL)
- FLAME CLASS :94V-2
- COLOR: BLACK
- UNIT: mm

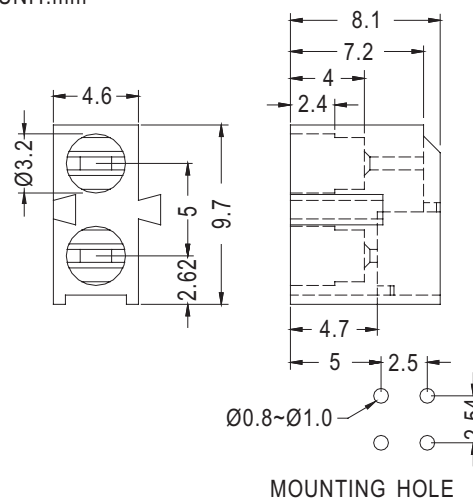
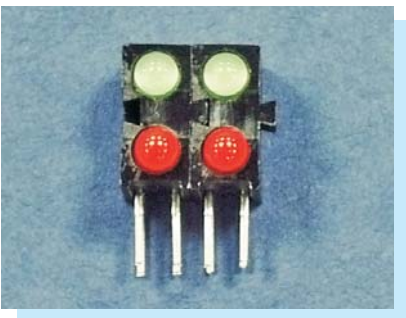

PART NO	PACKAGE
LED-6302	2000