

WIRE MOUNT

PLASTECH

- MATERIAL: NYLON 66 (UL)
- FLAME CLASS :94V-2
- COLOR:NATURAL
- UNIT:mm

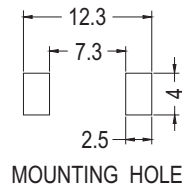
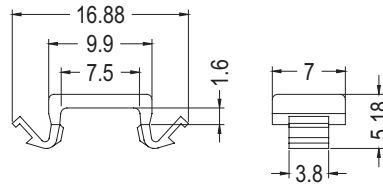
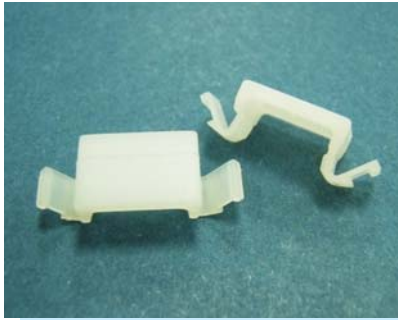

NEW

PART NO	PACKAGE
CCMH-7.5	1000

WIRE MOUNT

PLASTECH

- MATERIAL: NYLON 66 (UL)
- FLAME CLASS :94V-2
- COLOR:NATURAL
- UNIT:mm

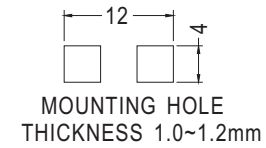
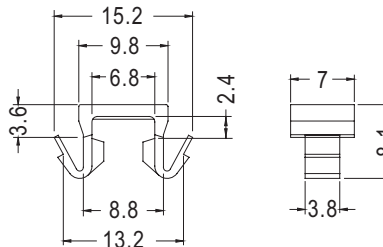
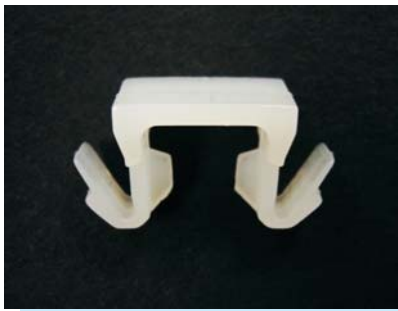

PART NO	PACKAGE
CCMH-12	1000

WIRE MOUNT

PLASTECH

- MATERIAL: PPO (UL)
- COLOR:BLACK
- UNIT:mm

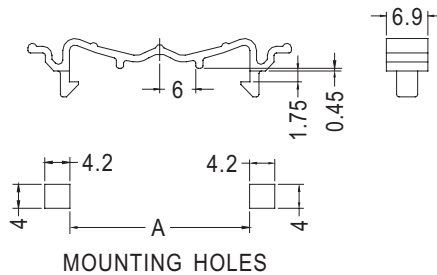
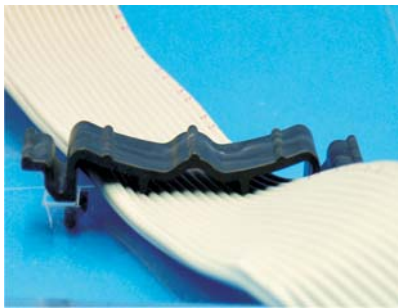

PART NO	A	PACKAGE
CCMA-30	30.0	1000
CCMA-40	40.0	

WIRE MOUNT

PLASTECH

- MATERIAL: NYLON 66 (UL)
- FLAME CLASS :94V-2
- COLOR:NATURAL/BLACK
- UNIT:mm

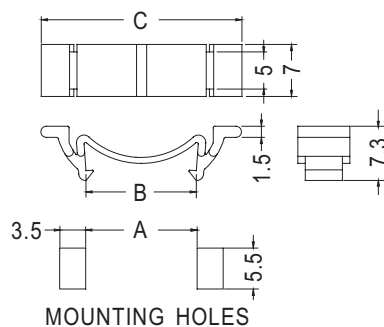

PART NO	A	B	C	PACKAGE
CCMB-15	15.0	17.85	27.0	1000
CCMB-30	30.0	32.18	42.0	