

- MATERIAL: NYLON 66 (UL)
- FLAME CLASS :94V-2
- COLOR:NATURAL
- UNIT:mm

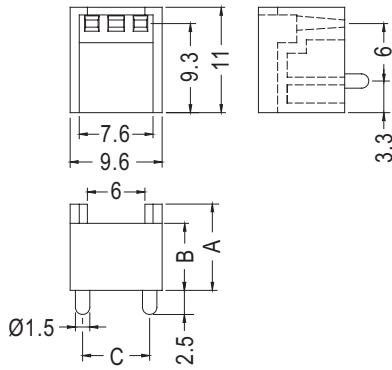

| PART NO | A | B | C | PACKAGE |
|---------|------|------|-----|---------|
| RCEB-7 | 9.0 | 7.0 | 7.0 | 1000 |
| RCEB-15 | 17.0 | 15.0 | 6.0 | |

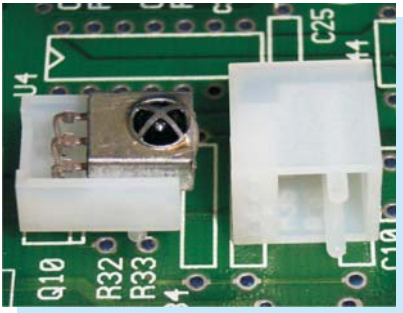
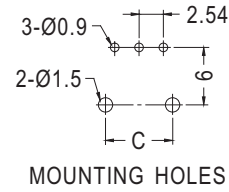

| PART NO | PACKAGE |
|---------|---------|
| RCEE-7 | 1000 |

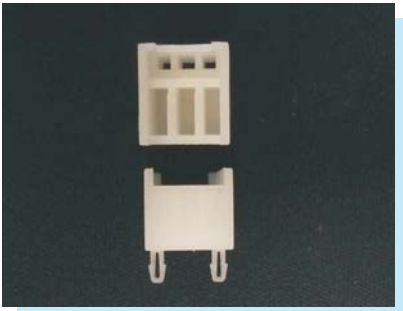
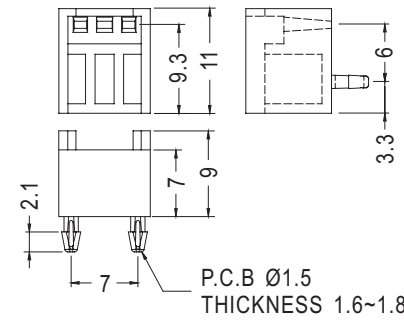

- MATERIAL: NYLON 66 (UL)
- FLAME CLASS :94V-2
- COLOR:BLACK
- UNIT:mm

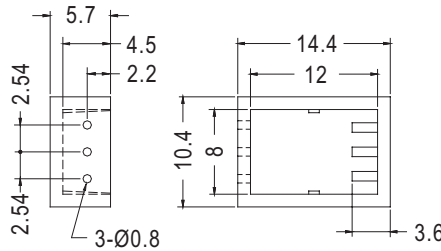
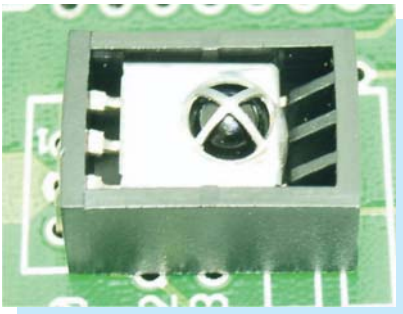

| PART NO | PACKAGE |
|---------|---------|
| RCEC-2 | 1000 |

- MATERIAL: NYLON 66 (UL)
- FLAME CLASS :94V-2
- COLOR:BLACK
- UNIT:mm

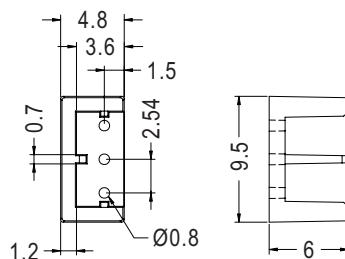
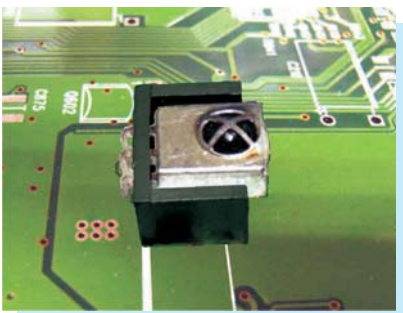

| PART NO | PACKAGE |
|---------|---------|
| RCEF-1 | 1000 |