

CRYSTAL WASHER

PLASTECH

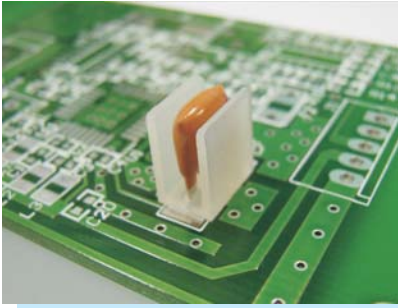

- MATERIAL: NYLON 66 (UL)
- FLAME CLASS :94V-2
- COLOR:NATURAL
- UNIT:mm

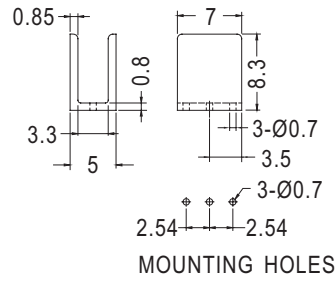

PART NO	PACKAGE
QCL-3	1000

PARTS HOUSING

PLASTECH

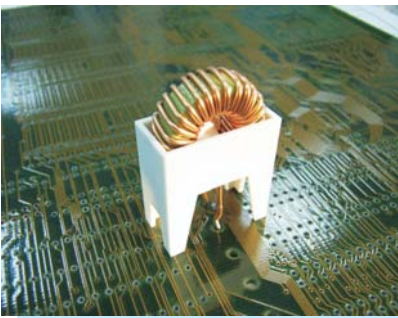

- MATERIAL:PBT (UL)
- FLAME CLASS:94V-0
- COLOR:NATURAL
- UNIT:mm

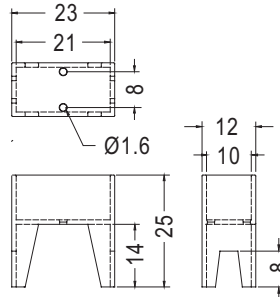

PART NO	PACKAGE
COILC-21	500

PARTS HOUSING

PLASTECH

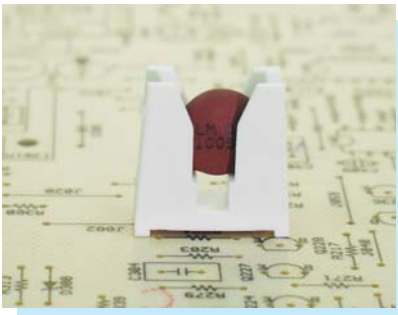

- MATERIAL:PBT (UL)
- FLAME CLASS:94V-0
- COLOR:NATURAL
- UNIT:mm

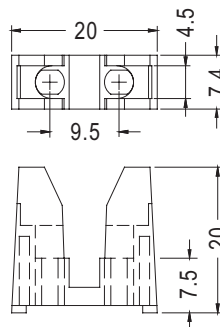

PART NO	PACKAGE
PHC-1	500

PARTS HOUSING

PLASTECH

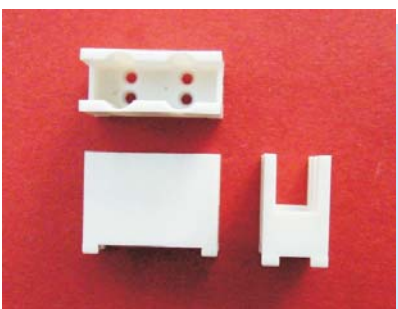

- MATERIAL:PBT (UL)
- FLAME CLASS:94V-0
- COLOR:NATURAL
- UNIT:mm

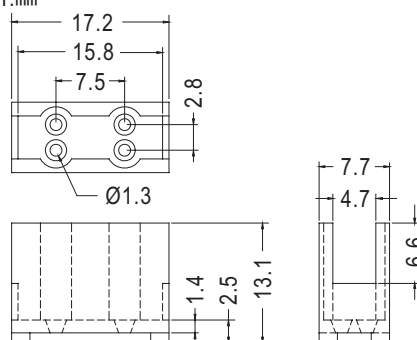

PART NO	PACKAGE
PHC-2	500